

Wireless Charging Tray : 241023-54-1

BMW 3 Series (F30) 02/2012-06/2015
 BMW 3 Series Touring (F31) 09/2012-06/2015
 BMW 3 Series Gran Turismo (F34) 06/2013-06/2016
 BMW M3 (F80) 06/2014-02/2017
 BMW 4 Series Coupé (F32) 10/2013-02/2017
 BMW 4 Series Gran Coupé (F36) 03/2014-02/2017
 BMW M4 (F82) 06/2014-02/2017
 BMW M4 Cabrio (F83) 09/2014-02/2017

INBAY

WIRELESS CHARGING

D

EINBAUANLEITUNG

Schwierigkeitsgrad



gering

hoch

GB

INSTALLATION GUIDE

level of difficulty



low

high



B

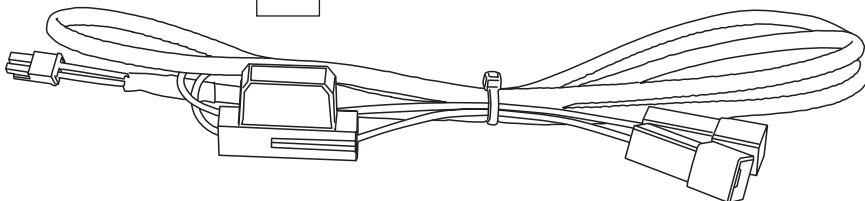

C

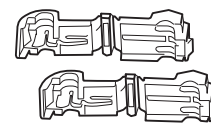

Ø 1,5mm² (rot / red)

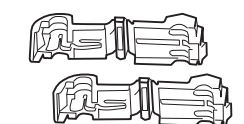

Ø 2,5mm² (blau / blue)

Sachgemäße Installation unter Beachtung dieser Einbauanleitung erforderlich. Achten Sie auf korrekte Anschlüsse. Verlegen Sie die Kabel so, dass Sie weder geknickt, gequetscht oder beschädigt werden können. Sorgen Sie dafür, dass sich die Kabel nicht in Gegenständen verfangen können.

Wir können keine Haftung für Schäden übernehmen, welche durch unsachgemäße Installation oder Nutzung verursacht wurden. Verwenden Sie darum ausschließlich das mitgelieferte Montagematerial.

Technische Änderungen vorbehalten, alle Angaben ohne Gewähr.

Das „Qi“ Logo ist Warenzeichen des „Wireless Power Consortium“

An appropriate installation in observance of these operating instructions is necessary. Please make sure the wiring is arranged so it is not bended or crimped due to the risk of cable break. Make sure that all connections are correct. Route the cable away from moving parts, do not allow the cable to be entangled, pinched or damaged in any way.

We will not be liable for damage due to improper installation or utilization. Use the specified accessory parts to prevent product failure.

Subject to technical modifications; no responsibility is accepted for the accuracy of this information.

The “Qi” symbol is a trademark of the “Wireless Power Consortium”





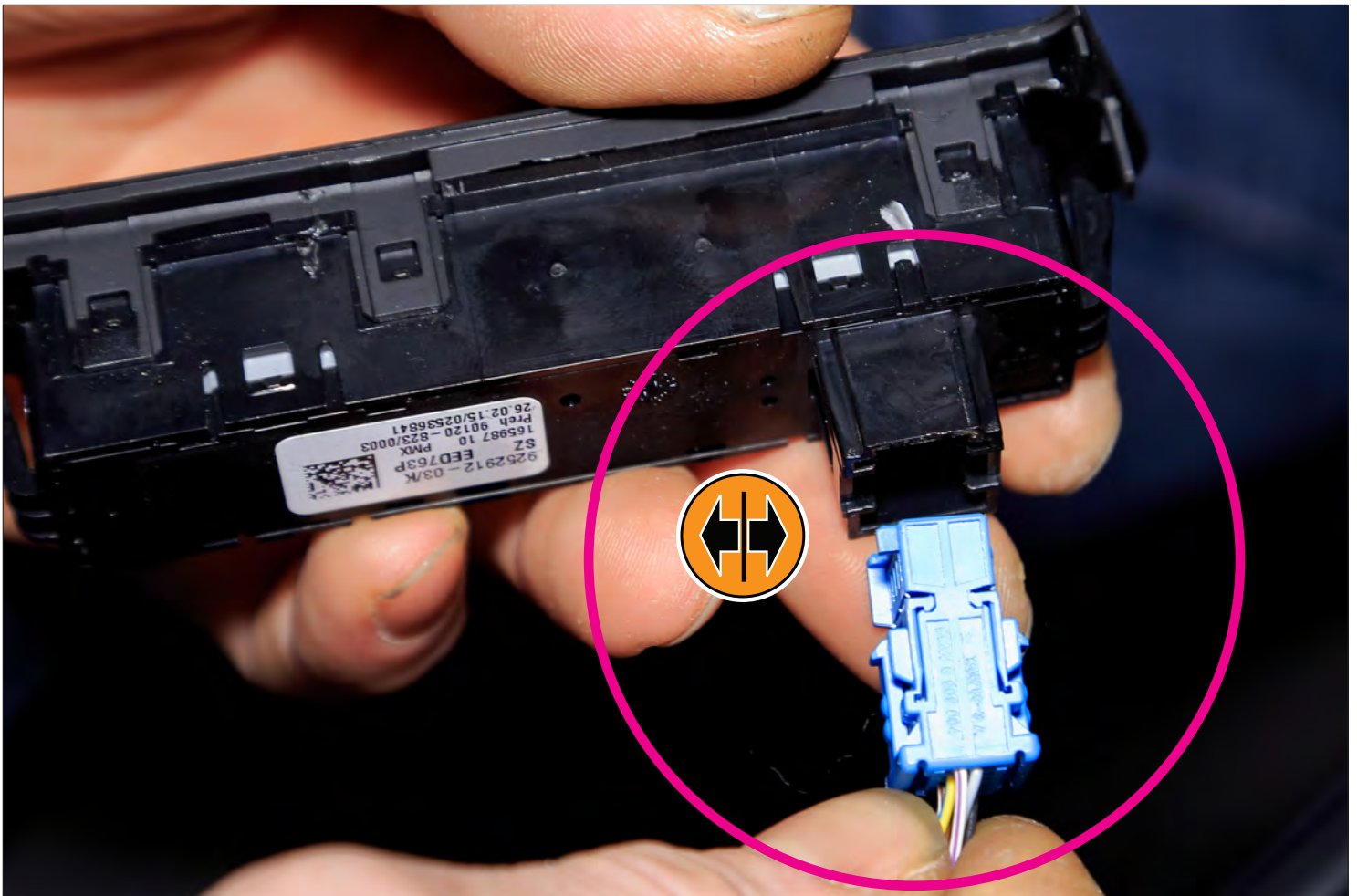





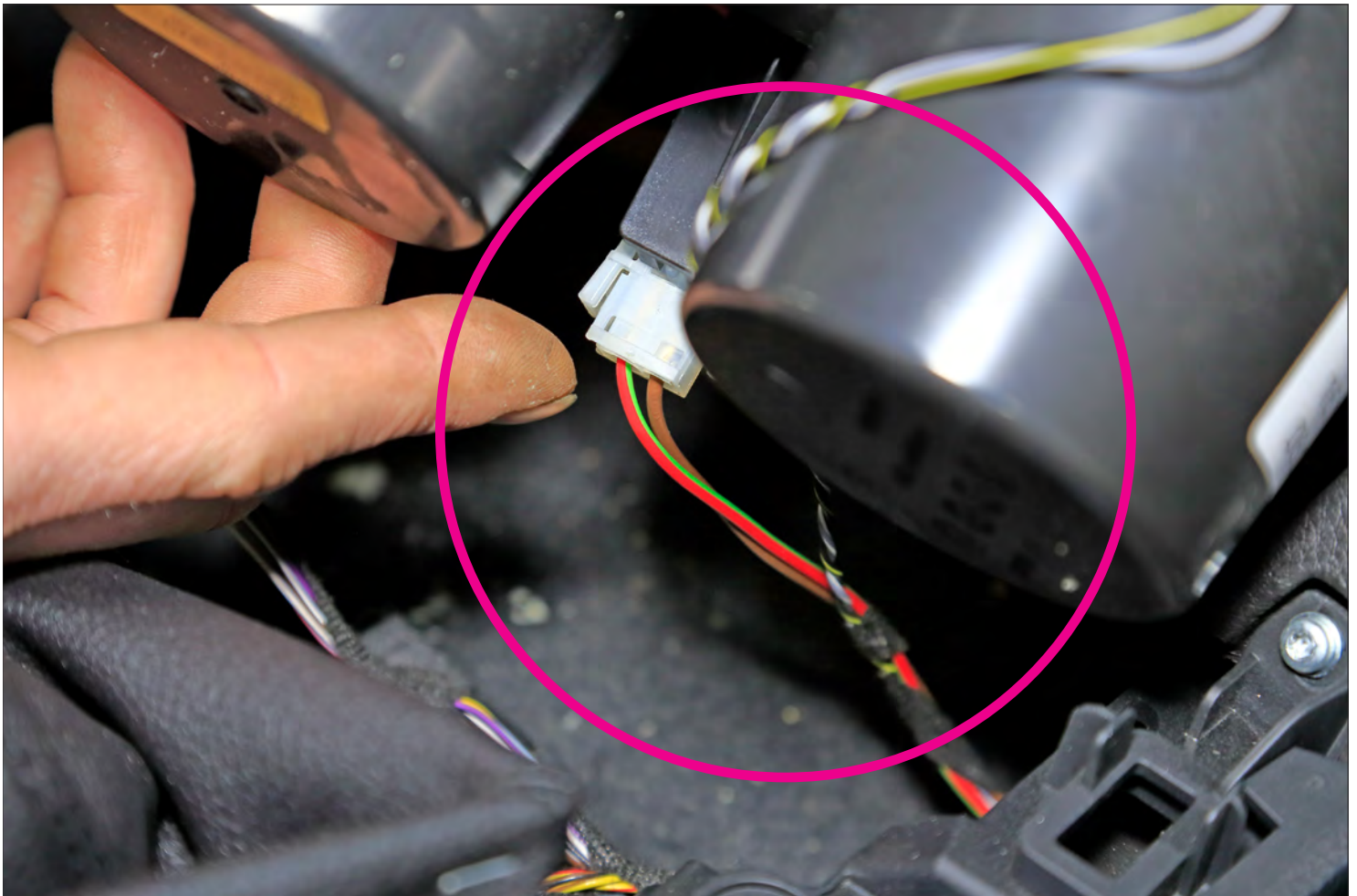

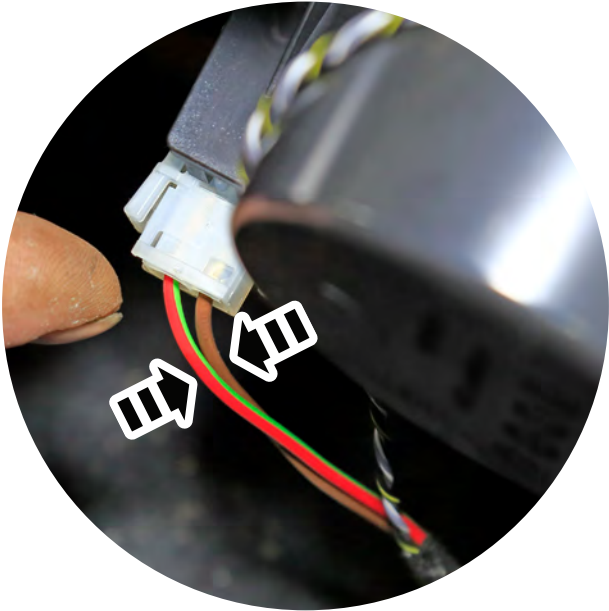

B Power-Cable

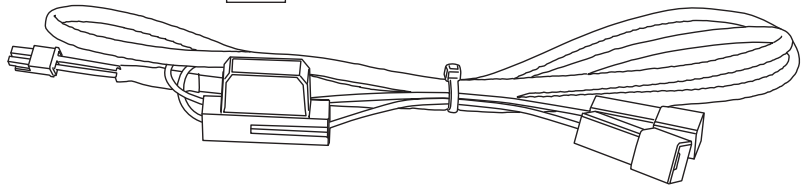

C Ø 2,5mm² (blue)

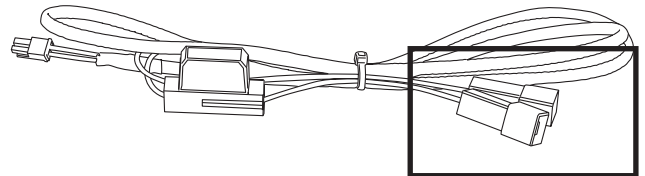
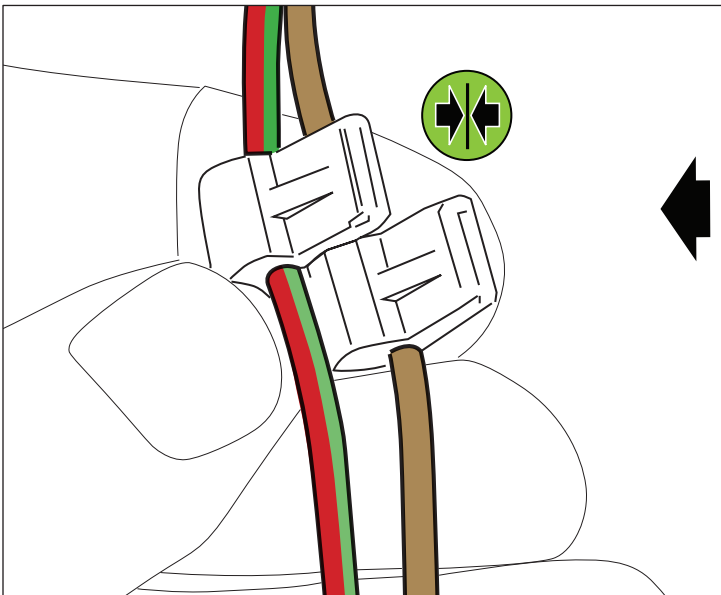
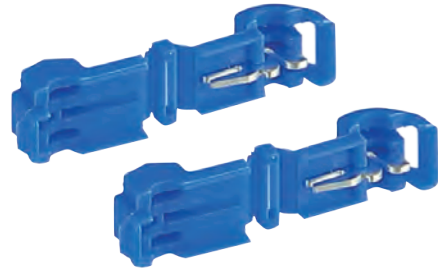

POLARITY ?

- GND



+12V switched

B

+12V switched (red)

- GND (black)

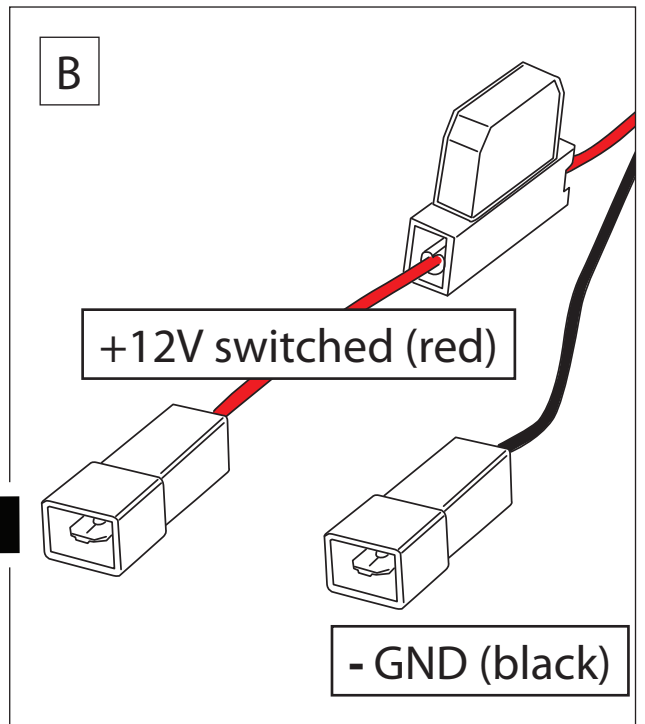

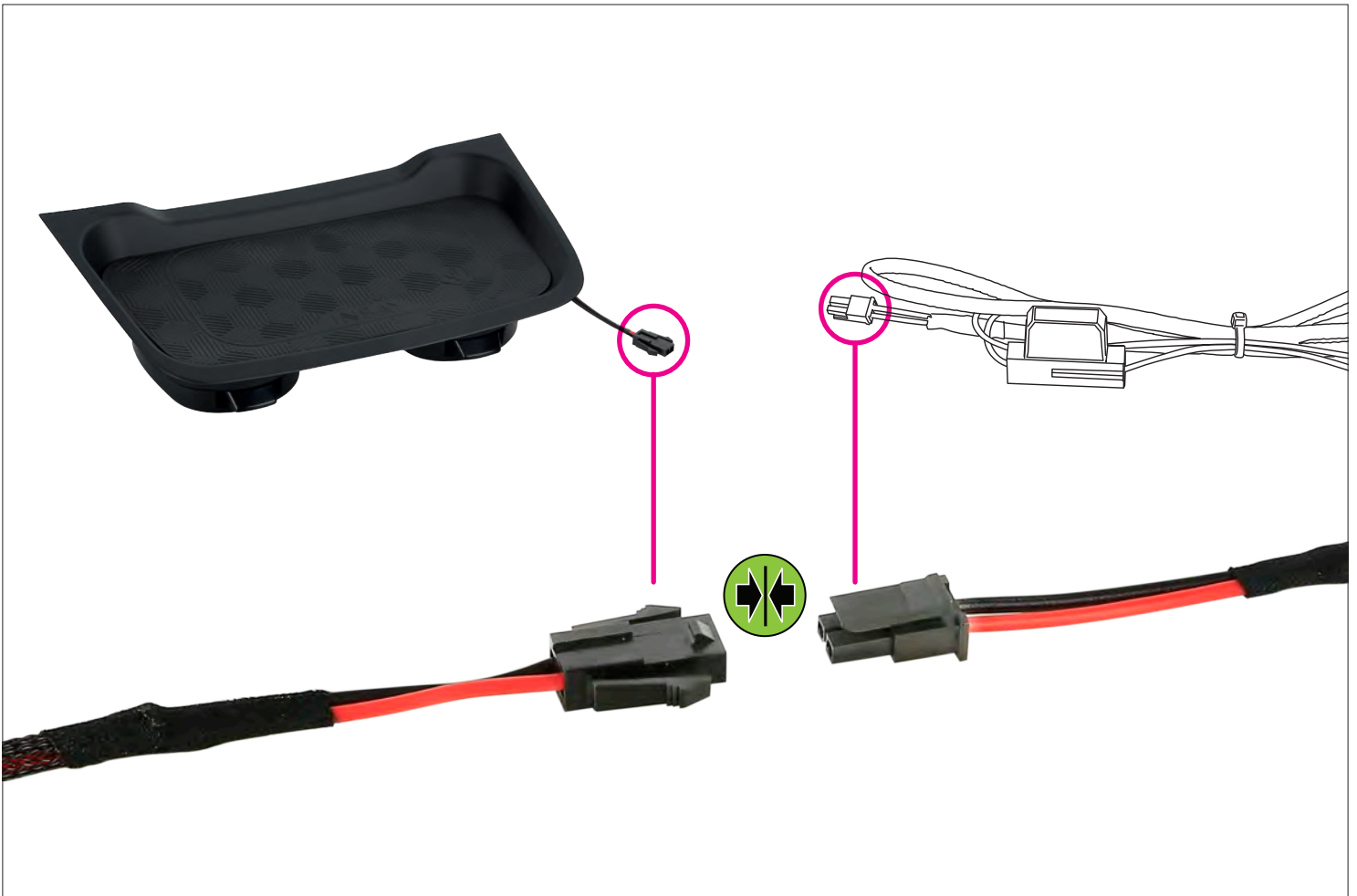





NO METAL OBJECTS - CAUTION HOT! - up to 55°C

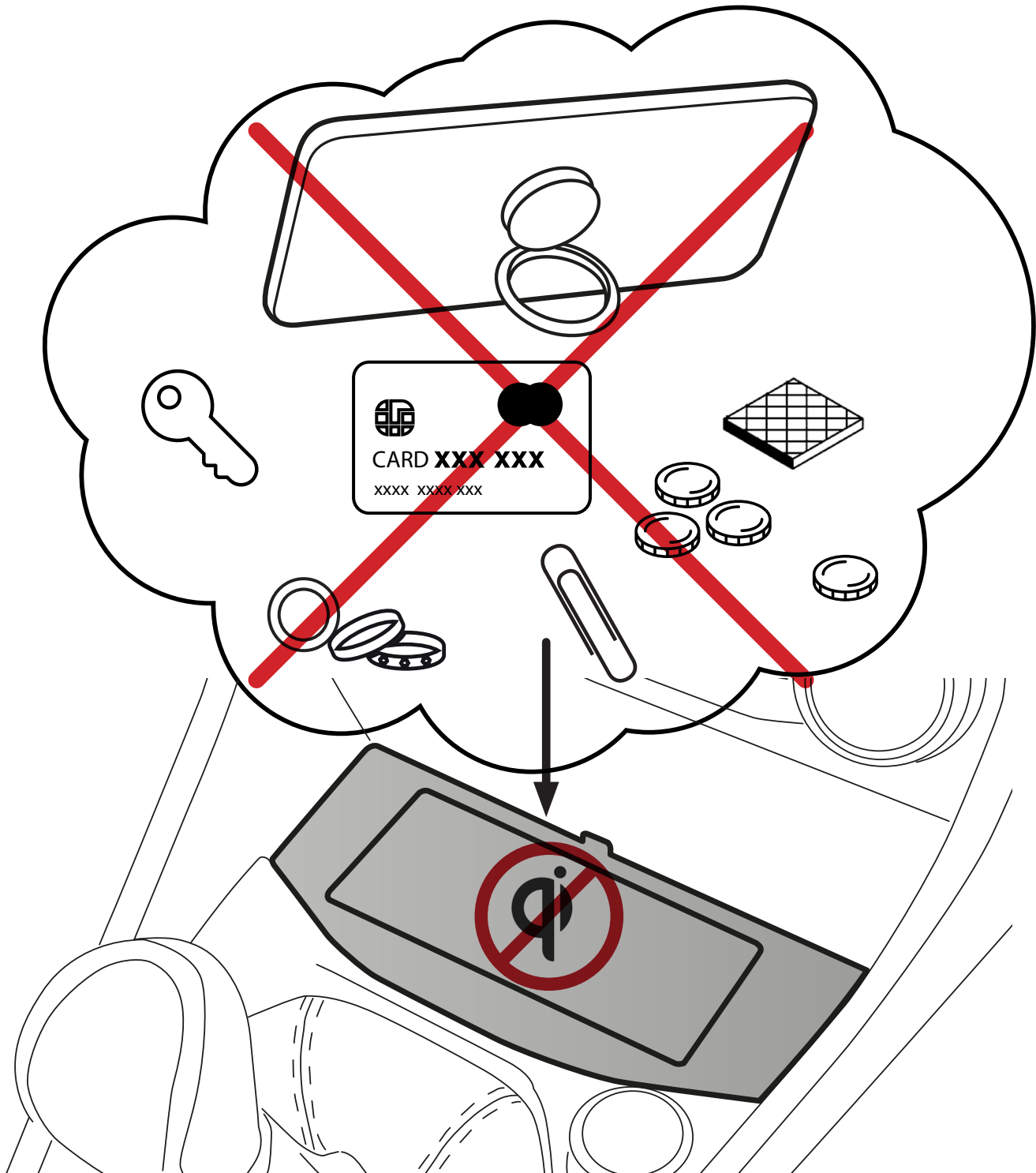

ACHTUNG!

Legen Sie keine anderen Gegenstände wie z.B. Münzen, Kreditkarten etc. in die INBAY Ablage. Insbesondere Smartphones mit angebrachtem Ring Ständer dürfen nicht verwendet werden!

CAUTION!

Don't place any other objects such as coins, credit cards etc. onto the INBAY surface. Especially smartphones with attached ring stand holder should not be used!

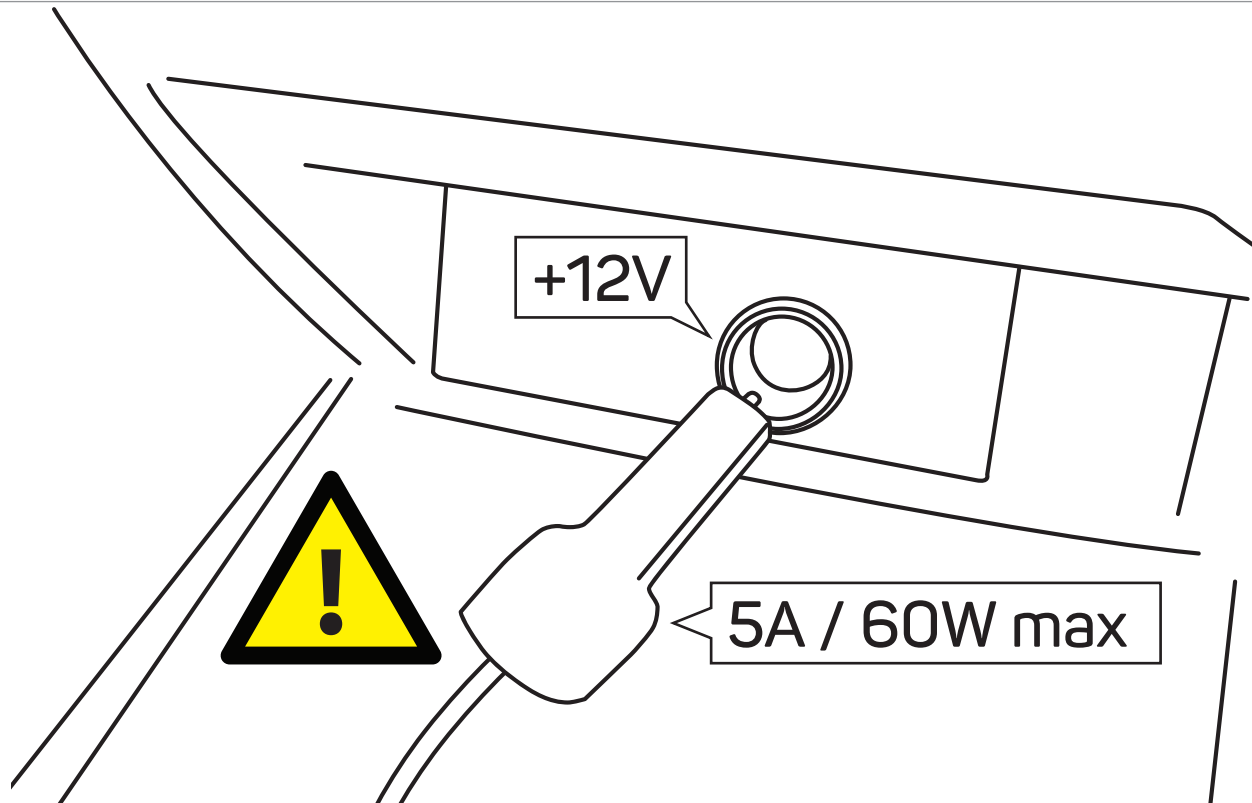

ACHTUNG! Nach der Installation dürfen keine Geräte/Verbraucher mit mehr als **5A / 60W** an der +12V Buchse betrieben werden, da sonst die Gefahr einer Überspannung besteht!

ATTENTION! After installation, devices/consumers with more than **5A / 60W** shall not be operated on the +12V socket. Otherwise a risk of overvoltage can occur!

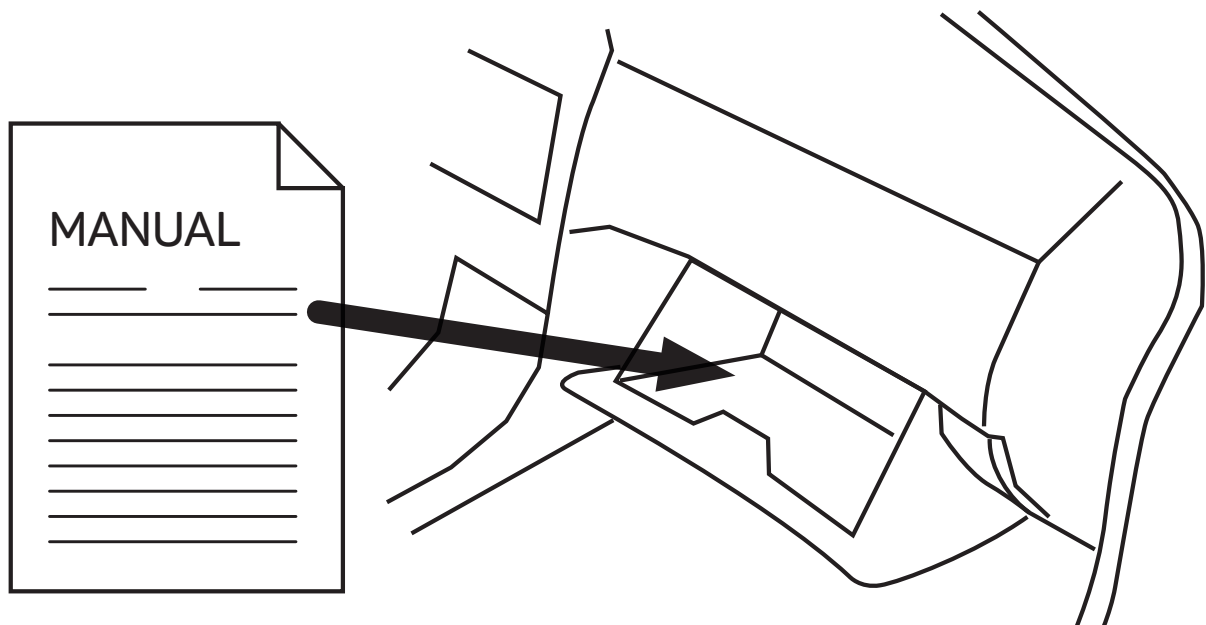

WICHTIG! NACH DER INSTALLATION MUSS DIESE EINBAUANLEITUNG IN DAS HANDSCHUHFACH DES KUNDENFAHRZEUGS GELEGT WERDEN.

IMPORTANT! AFTER INSTALLATION THE MANUAL HAS TO BE PLACED INTO THE DASH BOARD OF THE CUSTOMER'S CAR.